

ZDR 25 ZS 16-25

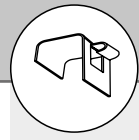

1

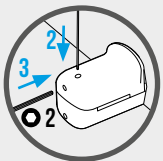
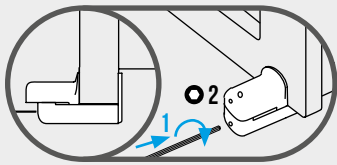
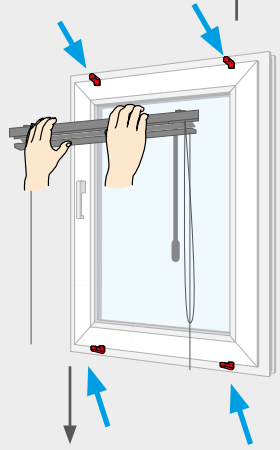
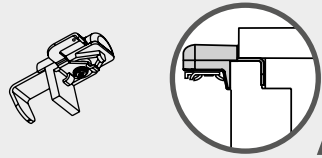
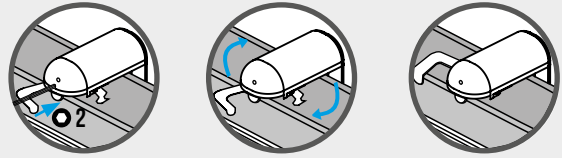

ZDR 25 ZS 16-25

1

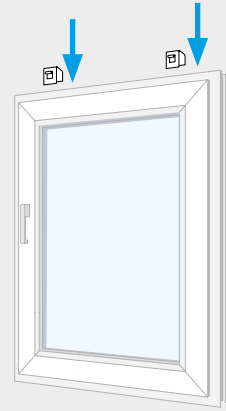
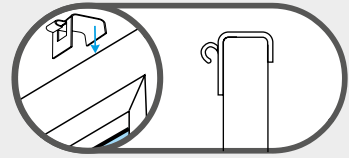

2

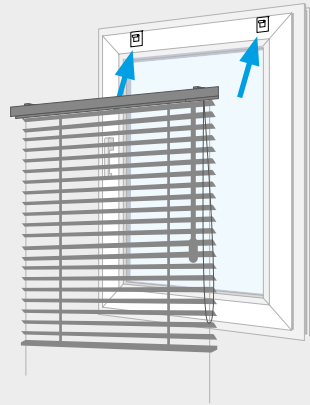

3

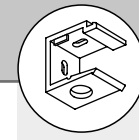
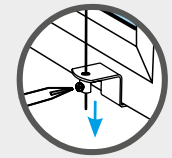
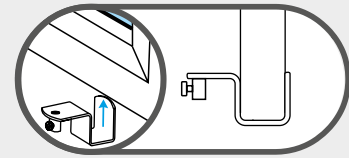

ZDR 25 ZS 16-25

1

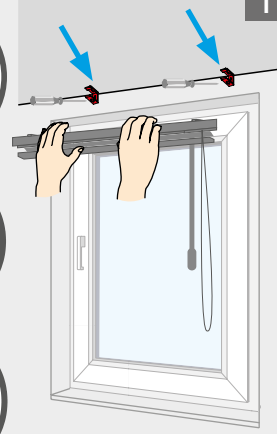
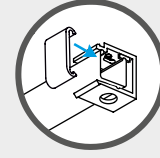
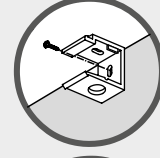
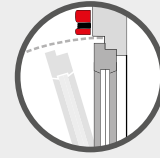
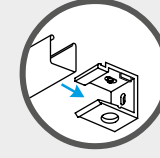
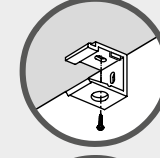

2



A

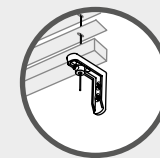
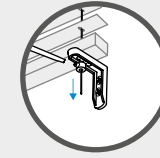
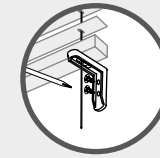

B

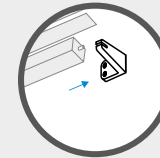
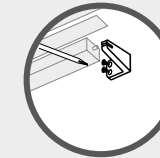

C

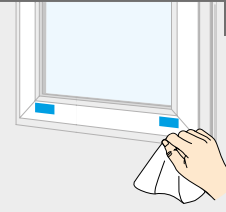
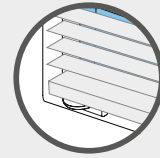
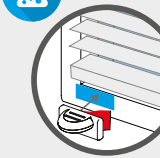

ZS 16 25 MM



ZDR 25 MM

ZDR 25 ZS 16-25

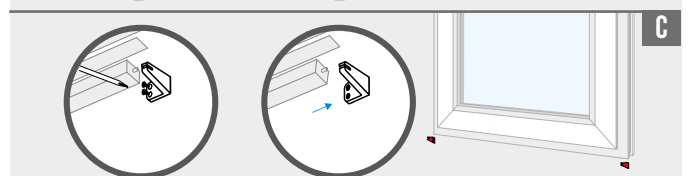
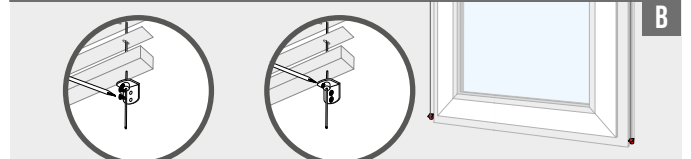
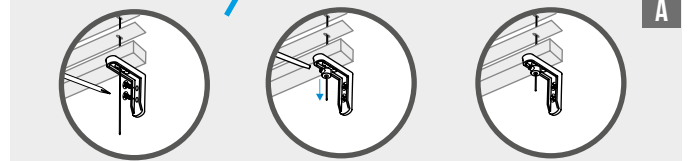
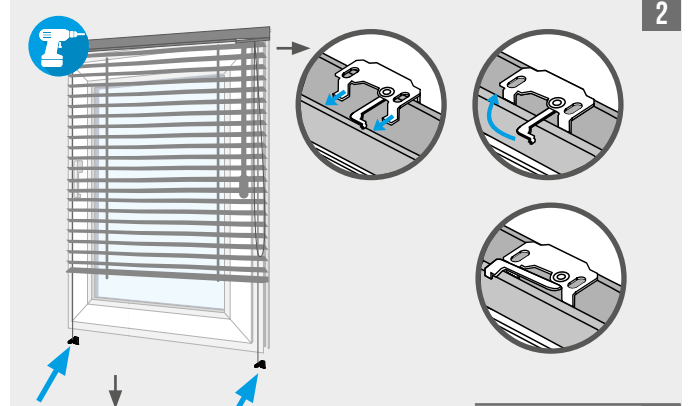
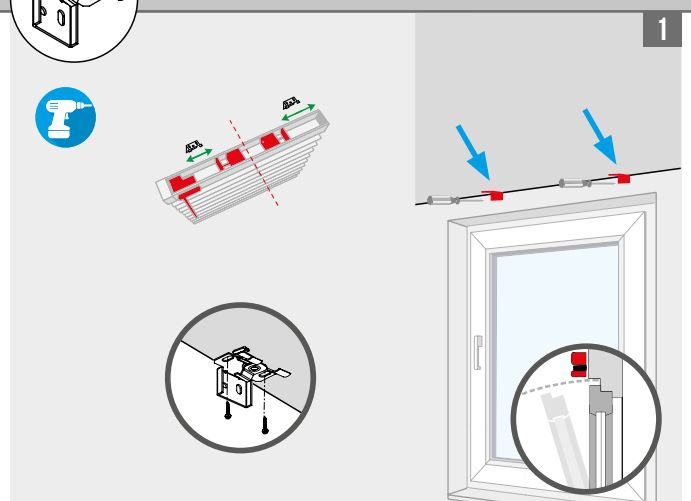

ZDR 25 ZS 16-25

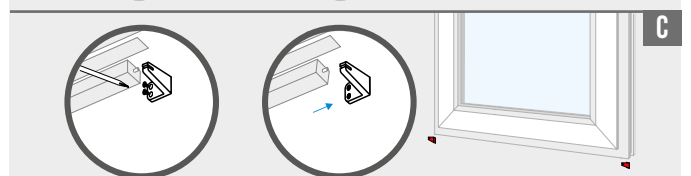
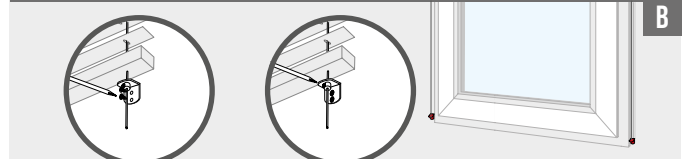
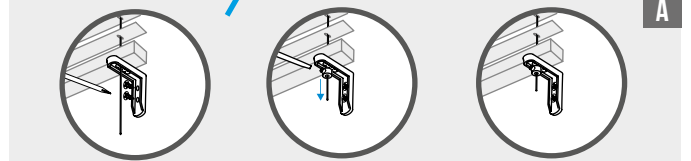
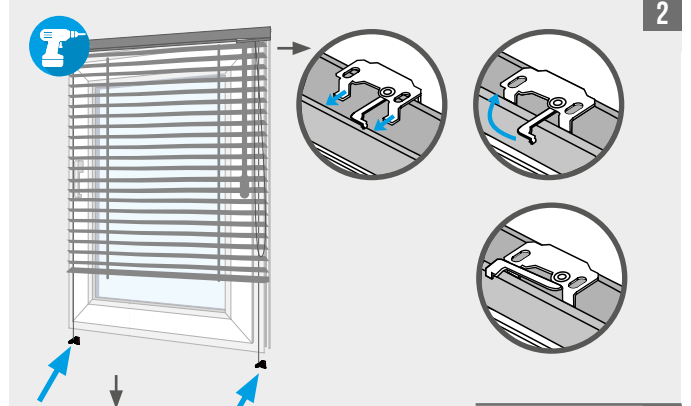
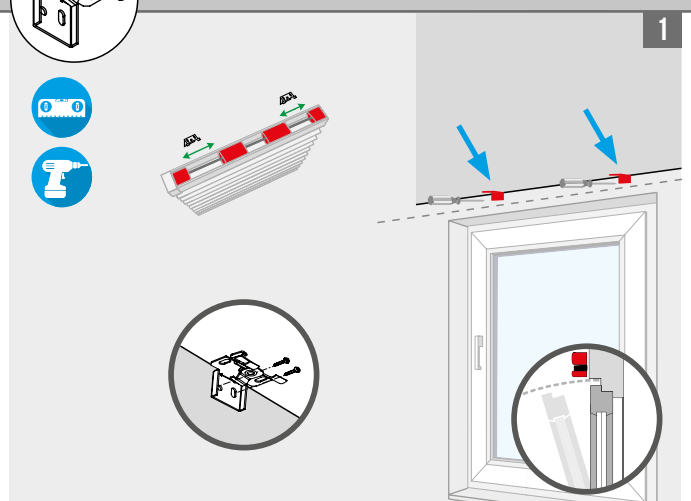

ZDR 25 ZS 16-25

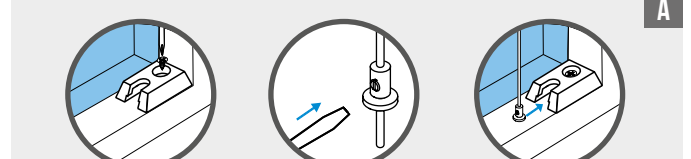
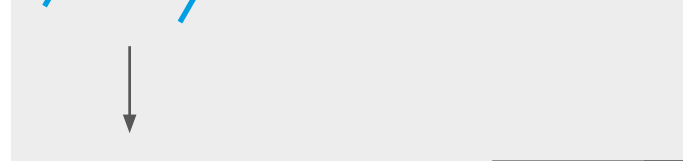
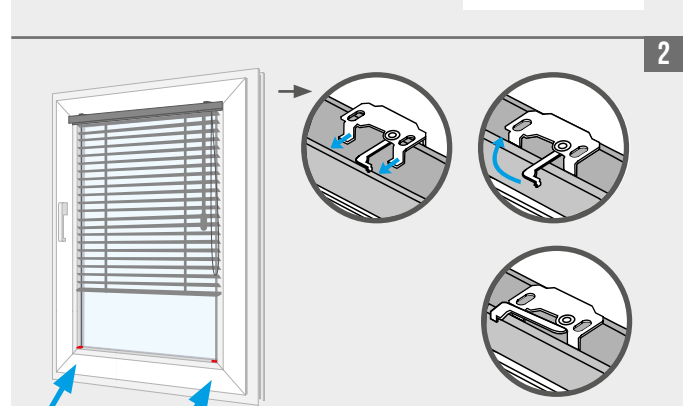
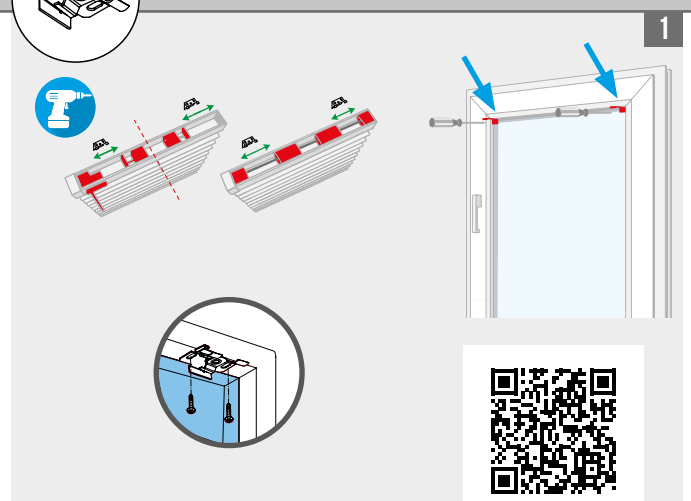

ZDR 25 ZS 16-25

