

PRODUCT TECHNICAL AND OPERATIONAL DOCUMENTATION
INSTALLATION MANUAL

- 11. Awnings
- 11.4 Terrace awning **JAMAICA**
- 11.4.1 Installation manual



PRODUCT TECHNICAL AND OPERATIONAL DOCUMENTATION**Installation manual****11.4.1 DT-E**

PRODUCT NAME:
TERRACE AWNING
JAMAICA

PRODUCT MANUFACTURER'S MARKING:

Manufacturer's name:

- SELT Sp. z o.o.

Manufacturer's head office:

- 45- 449 Opole, ul. Wschodnia 23A

Website

- www.selt.com

Plant address:

- Wydział Produkcji Markiz
45- 449 Opole, ul. Wschodnia 23A

Contact details:

- Tel: +48 77 553 21 00 (secretariat)
Fax: +48 77 553 22 00

E-mail:

- selt@selt.com

PRODUCT SAFETY MARKING:

- Product conforms to CE safety requirements
-

This Technical and Operational Documentation:

- Is valid from: 01 April 2017
 - Is valid for product versions designated above
-

Table of contents

1	Introduction.....	4
1.1	Product safety tips.....	4
1.2	Notes on symbols and marks.....	4
1.3	Definitions.....	5
1.4	Subject, designation, and contents of the documentation.....	5
2	Product technical information	6
2.1	Technical parameters	6
2.2	Jamaica awning construction	7
2.3	Bracket types	7
3	Product installation	8
3.1	General requirements for safe installation	8
3.2	Requirements for safe installation at heights	8
3.3	Preparation to installation.....	9
3.4	General guidelines for installation	9
3.5	Installation tools	10
3.6	Jamaica awning installation – wall brackets.....	10
3.7	Jamaica awning installation – ceiling brackets.....	14
3.8	Jamaica awning installation – roof rafter brackets	14
3.9	Electric drive	14
3.9.1	Connection to electrical installation	15
3.9.2	Remote operation	16
3.9.3	Start-up and adjustment	16
3.10	Manual drive	16
4	Final remarks	17
4.1	Completeness and qualitative state of delivery	17
4.2	General conditions for transport and storage of the product	17
5	Marking and labelling the product with CE mark	19
5.1	Product compliance with the CE standard	19
5.2	Information accompanying the CE mark.....	19

1 Introduction

1.1 Product safety tips





The product was manufactured in accordance with the latest know-how in the area of constructing and manufacturing technology and is delivered in condition assuring operational safety.

Safe product construction was achieved thanks to:

No.	Subject	European legal basis	Polish legal basis
1	External blinds. Performance requirements including safety	EN – 13561:2015	PN-EN 13561:2015
2	Construction Products Regulation (CPR)	Regulation (EU) no 305/2011 of the European Parliament and of the Council	DZ. U [Journal of Laws] 2004, No. 92, item 881 as amended by, DZ. U [Journal of Laws] 2016, No. 1570; 2015, No. 1165; 2016, No. 542
3	Essential requirements for machines	Directive 2006/42/EC of the European Parliament and the Council	Resolution of the Minister of Economy of 21 October 2008 DZ.U. [Journal of Laws] 2008 no. 199, item 1228 as amended DZ.U. [Journal of Laws] 2011.124

1.2 Notes on symbols and marks

The below symbols (icons) denote particularly important information concerning threats and safety.

Icon	Icon meaning	Information
	INFORMATION	Prior to using the product, its operating manual should be read. Following the operating manual guarantees: - failure-free use of the product, - warranty coverage against product defects. Keep the operating manual for safety of people.
	INFORMATION	No harmful or dangerous consequences for people or facilities.
	ATTENTION!	A situation likely to cause product damage or other damage. No threat for people.
	WARNING!	Threat of danger
	DANGER!	This symbol denotes all information concerning danger, failure to observe which brings about threat to human life and health. Risk: threat of serious injury or death. Dangerous operation which may cause injuries or product damage.

	WARNING!	Threat to human life or health due to electric shock.
---	----------	---

1.3 Definitions

The terms and definitions used within this documentation shall mean:

Product: terrace awning JAMAICA

Awning:

Terrace awnings, as external sun protection screens are installed solely on the outside of the building for protection from sun light for terraces, restaurant patios, balconies, shop windows etc. Rolling up and down of the awning fabric is performed with the use of an electric control mechanism or manual crank.

Awning fabric:

Part of the product serving for protection from sun light, but also having a decorative function. Manufactured from high quality materials is put into motion with manual or electric control mechanism, assuring the product fulfils its function.

1.4 Subject, designation, and contents of the documentation

Products manufactured by **SELT SP. Z O.O.** are the subject of this documentation.

This documentation is valid for all type of **JAMAICA terrace awning**.

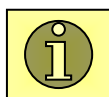

The documentation is valid jointly with the information concerning a specific product, which is available on the website www.selt.com

The documentation is a component of product delivery and should be constantly stored in its proximity.

The documentation includes:

- important recommendations concerning product installation, use and maintenance,
- important recommendations concerning product transport and storage,
- tips following which will assure long-time and fault-free use of the product.

SELT SP. Z O.O. shall not bear responsibility for damage resulting from failure to follow recommendations included in the documentation.

In order to further improve the product, SELT SP. Z O.O. reserves the right to introduce changes which, while maintaining the essential technical parameters, shall be deemed purposeful for improving product operation quality and safety of use.

SELT SP. Z O.O. with a head office in Opole shall hold the copyrights to this documentation. The documentation cannot be used without permission, either partially or as a whole, for any concurrent business activity nor can it be made available to third parties.

2 Product technical information

Product technical specification is available at www.selt.com after log in.

2.1 Technical parameters

Projection:	1,6m, 2,1m, 2,6m, 3,1m,3,6m
Maximum projection	3,6 m , (3,1m with volant)
Minimum width	Projection + 0,5 m
Maximum width	7 m, 6m with projection 4,1m ,(5,9m with volant)
Roller tube diameter	70/78 mm
Arms	Folding, aluminium, with springs and Flyer's chain, Possibility of using overlapping arms.
Tilt angle	5° - 40°
Manual drive	Crank 1,5 m, 1,8 m, 2,2 m
Optional hood	Yes
Electric drive	Motor, motor with emergency override, remote control receiver, weather sun-wind automation.
Construction colour	White, beige, brown, silver, structural graphite
Fabric	C. 140 patterns
Valance	Height 21 (±0,5 cm), shape according to templates. Possibility of roll-up valance – volant application.
Application	External
Mounting brackets	Wall, ceiling, roof rafter

The tolerance of external dimensions is ± 2 cm

Due to technological reasons, slight differences in colour shade are deemed acceptable and they are not a ground for complaint.

Motors technical data

www.selt.com → PRODUCTS → AUTOMATION → ALL → MOTORS

2.2 Jamaica awning construction

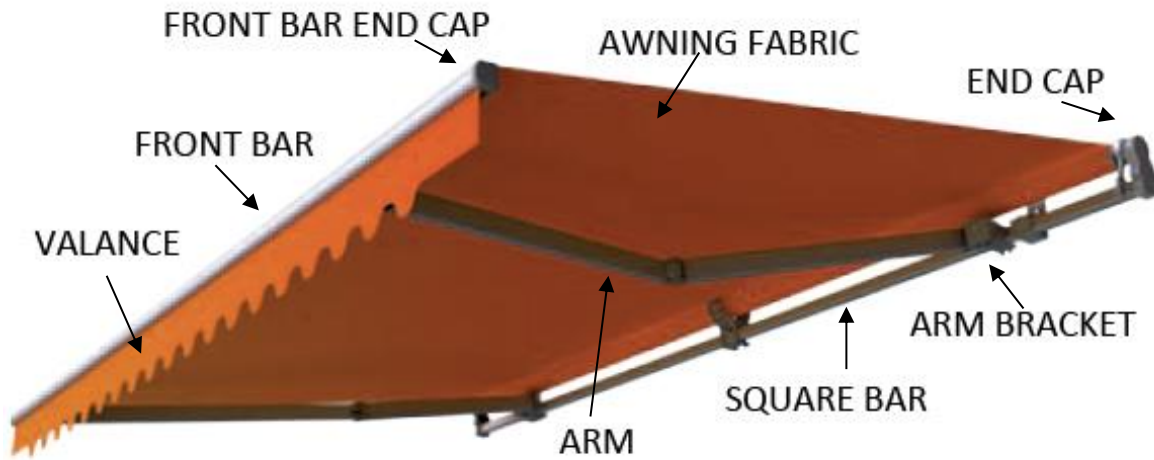

2.3 Bracket types

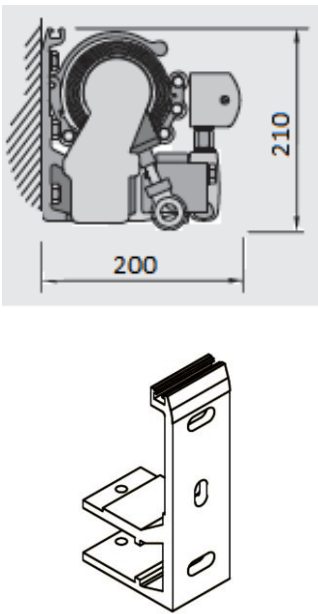
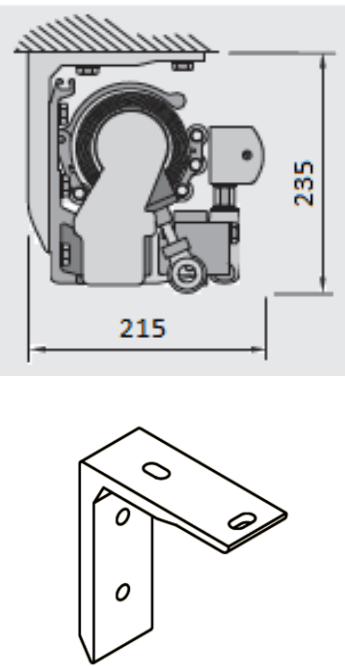
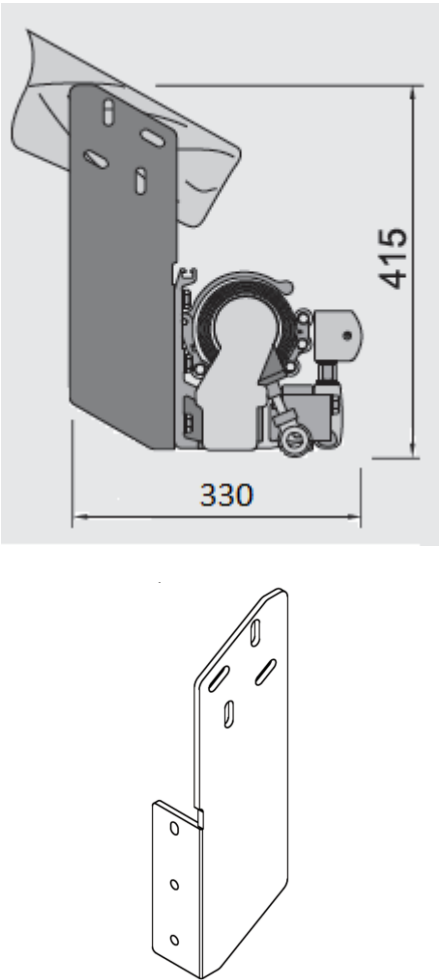
Wall bracket	Ceiling bracket	Roof rafter bracket
 <p>Diagram showing the wall bracket installation with dimensions 200 (width) and 210 (height). Below the diagram is a 3D perspective view of the wall bracket.</p>	 <p>Diagram showing the ceiling bracket installation with dimensions 215 (width) and 235 (height). Below the diagram is a 3D perspective view of the ceiling bracket.</p>	 <p>Diagram showing the roof rafter bracket installation with dimensions 330 (width) and 415 (height). Below the diagram is a 3D perspective view of the roof rafter bracket.</p> <p>Option with hood</p>

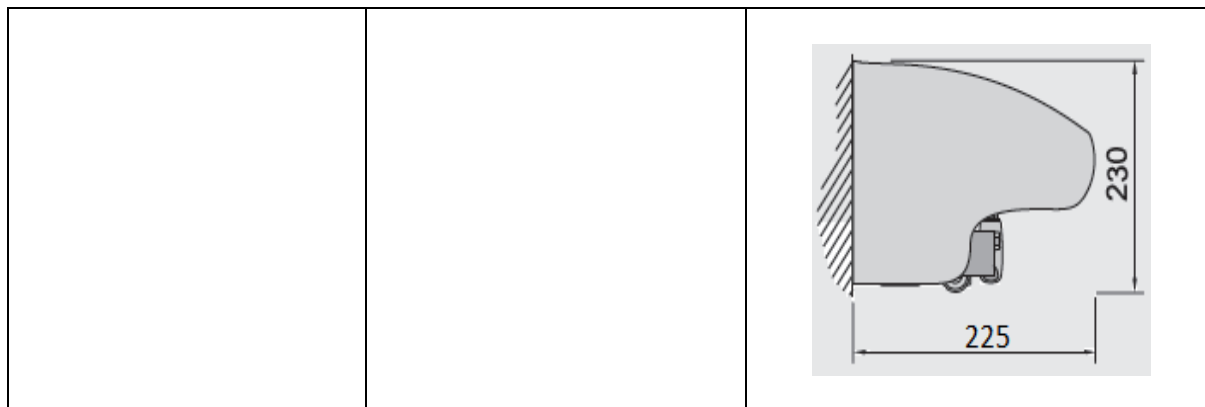

3 Product installation

The following part covers general requirements of the product installation. Proper installation is necessary for efficient operation of the product. SELT SP. Z O.O. recommends to use services of skilled installation crews what guarantees the Purchaser proper installation.

3.1 General requirements for safe installation

- it is necessary to follow general rules of construction art
- it is necessary to follow health and safety regulations, especially concerning work with electricity and at heights,
- product should be installed on even and dry wall surfaces that at the same time ensure proper strength and are completed according to general rules of building art,
- before starting the installation remove all unnecessary elements from the installation area.

3.2 Requirements for safe installation at heights



Installation of the product, because it requires performing work at heights, is particularly dangerous because it poses a high risk of danger to human health and safety and in particular fall from height.

Preparation of a plan on health and safety during installation is the responsibility of the Purchaser.

Purchaser should determine specific requirements of health and safety when working at height, and especially to ensure:

- direct supervision of work execution by the designated person (e.g. the foreman),
- adequate safeguards measures, in particular protective equipment against falls from height,
- detailed instruction of employees performing work at heights.

Work at heights above 2 meters, requiring using personal protective equipment against falls from height, must be performed by at least 2 people.

Work at heights should be organized and carried out in a way that does not force employees to lean out of the railings or outline of a device on which they stand. The buyer has an obligation to ensure that areas of work at heights can be accessed only by authorized and informed personnel. Health and

safety professionals should inform employees residing or staying at the conduct of such works or in the vicinity of the site about conducted operations at heights and the necessary safety measures to be applied during this work.

3.3 Preparation to installation

- unpack product and check if it contains all necessary elements for installation,
- make sure that the base where product will be mounted provides sufficient bearing capacity for safe installation and operation of the product,
- prepare set of tools necessary for installation.

3.4 General guidelines for installation

- To avoid the risk of hand and fingers harm during opening and closing of the awning, the awning should be installed on such height so that the lowest element of the awning after it is opened is at least 2200mm above the ground,
- The product should be protected against any stains made by e.g. silicon, mortar or mounting foam, which may cause its damage,
- Using any chemical substances containing bituminous substances or any other substances making reactions with the product is forbidden,
- In case of installation in public places, e.g. hospitals, schools, boarding schools etc. The placement of switch/remote control device should be marked according to health and safety regulations,
- In case of remotely operated awning, bracket for remote control should be installed in place not available for children,
- Electrical installation, first programming of motor and specialized service can be conducted solely by specialized service companies.

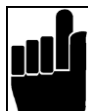

Awning installation, adjustment and test its testing can be carried out by service crew or trained persons only. Person conducting the installation and first run is responsible for appropriate fixing of the awning including fixing elements, allowing for its correct operation and parameters.



During the regulation of awning tilt angle, pay attention to the correctness of roller tube half-ring brackets setting, so that neither the roll nor the roller tube bracket's upper limiter pushes/scratches the fabric. Possible regulation of the angle should be performed with M6 nut on a M6x80 screw.



Improper installation may cause hazardous situation for the user.

3.5 Installation tools

	<p>drills hammer drill, ladder/scaffolding, screw-driver, hammer, measure tape,</p>	<p>pencil/marker, spirit level, ring and flat wrenches Allen keys, anchors.</p>
--	---	---

3.6 Jamaica awning installation – wall brackets

For base – uncracked concrete C20/25 class and no higher than C50/60:

- Anchors M10x110 A4, M10x150 A4 embedded on injection mortar (recommended anchors from Fischer FIS A M10x110 A4 on resin FIS V360, embedment depth in concrete shall be 60 mm, or equivalent product from different supplier).
- Distance from anchor axis to base edge: min. 45 mm in case of M10 anchor.
- Minimum base thickness is 150 mm for M10 anchor.

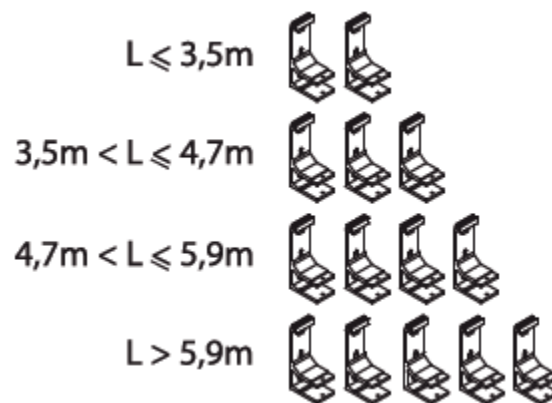

<p>1) Prepare installation tools according to the list.</p>	<p>2) Start the installation with marking installation spots for wall brackets. Level the bracket vertically with spirit level and mark places for installation holes.</p>	<p>3) Drill in marked places.</p>	<p>4) Fix installation anchors.</p>
---	--	-----------------------------------	-------------------------------------

5) Install wall bracket in position presented by the picture in permissible manner using: three holes or upper and lower hole or middle and lower hole.



ATTENTION!

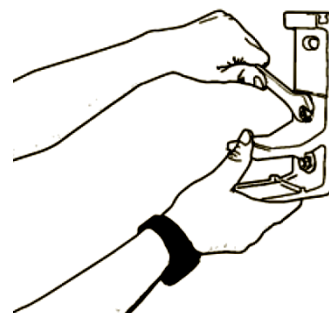
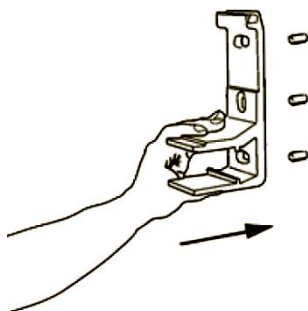
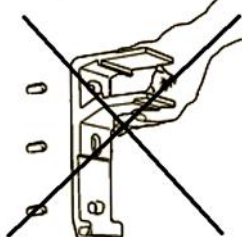

6) Based on the first bracket mark installation places for remaining ones – pay particular attention so that brackets are installed at the same horizontal level and in the same plane.

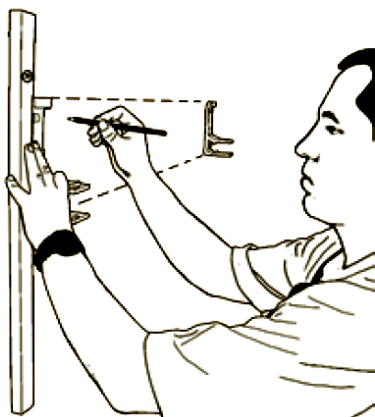

7) Drill holes in marked places.

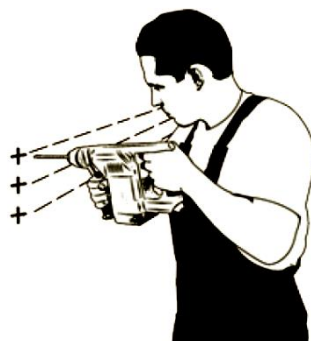

8) Fix installation anchors.



9) Install remaining wall brackets.

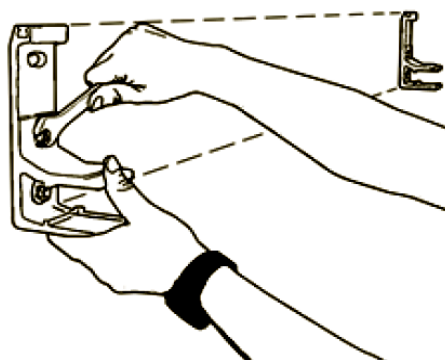
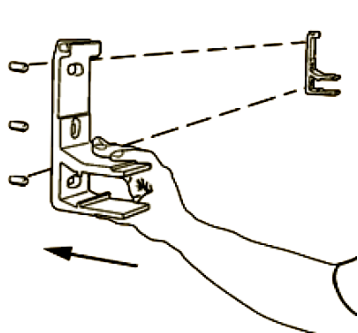

10) Slide the awning on wall brackets so that the construction is maximally pressed to the back (Note – before placing the awning verify the alignment of brackets – wall surface should be of the same thickness at installation spots).



11) Secure square bar with M8x65 screws and put PVC cover on them.

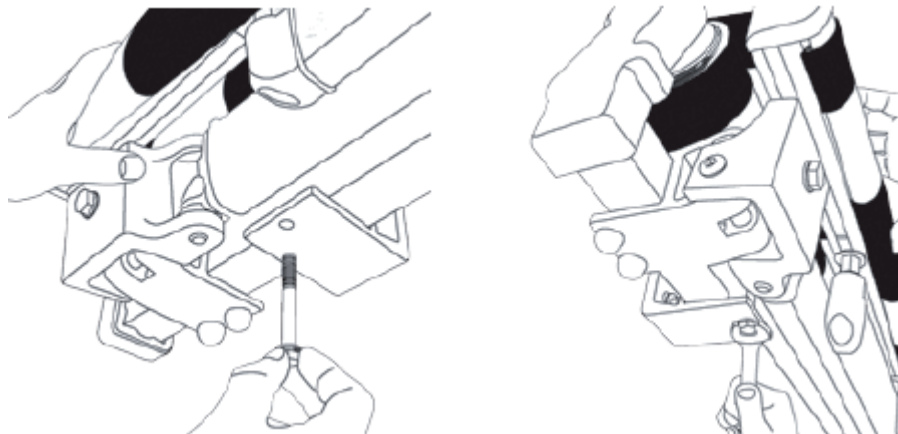

12) Open the awning slightly.

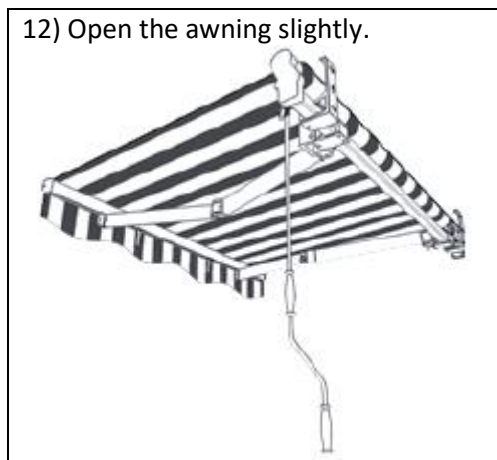

13) If necessary adjust the arm level by loosening or tightening the internal M5 screw in arm brackets.

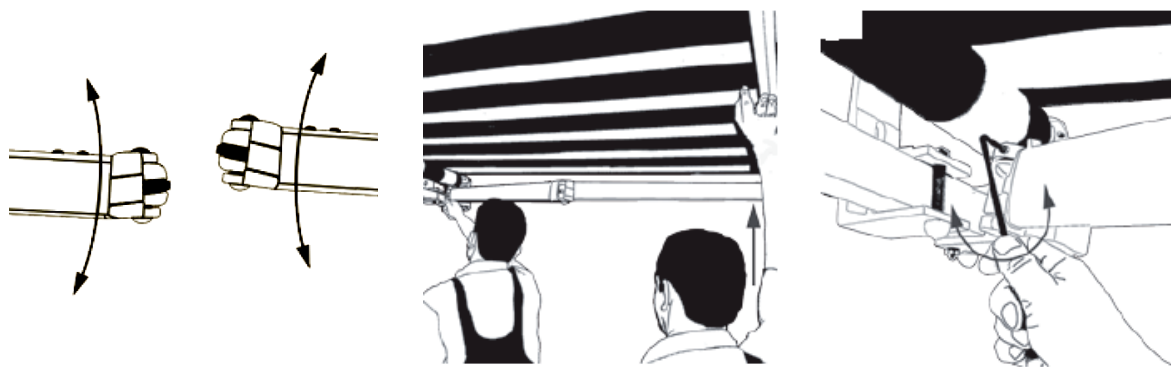

14) With spirit level check if the arms close to one plane.

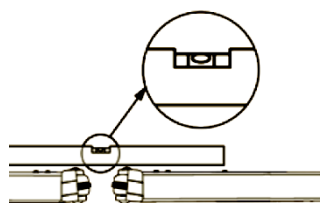

15) Open the awning completely.

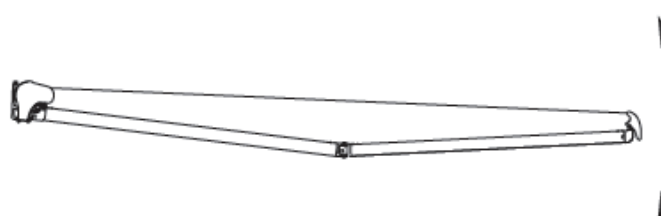

16) To change awning tilt angle loosen (to increase tilt angle) or tighten (to decrease tilt angle) with flat wrench the regulation screws in arm brackets.

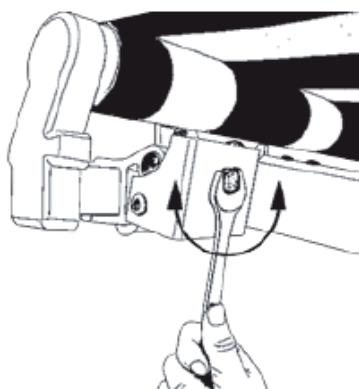

17) With spirit level check if front bar is levelled horizontally.



3.7 Jamaica awning installation – ceiling brackets

- Brackets should be installed in the same order and manner as wall brackets.
- Make sure that ceiling brackets are aligned, i.e. in the same distance from the wall.
- To the installed ceiling brackets install wall brackets with set of M10x35 screws with washers and nuts. Slide the awning on wall brackets so that the construction is maximally pressed to the back.
- Secure square bar with M8x65 screws and put PVC cover on them.

3.8 Jamaica awning installation – roof rafter brackets

- Roof rafter brackets should be installed to roof rafters the closest to awning edge possible, remaining brackets place in equal intervals.
- Brackets should be installed in the same order and manner as wall brackets.
- Install roof bracket with wood fixing elements.
- Based on first installed roof rafter bracket (base) measure placement of the remaining brackets – make sure that roof rafter brackets are aligned, i.e. in the same distance from rafter edge.
- Remember to install left and right roof rafter bracket alternatively, i.e. starting from awning right edge (looking at the awning from the front).
- To the installed roof rafter brackets install wall brackets with set of M10x35 screws with washers and nuts. Slide the awning on wall brackets so that the construction is maximally pressed to the back.
- Secure square bar with M8x65 screws and put PVC cover on them.

3.9 Electric drive

The installation must be performed by an electrician possessing appropriate permissions and professional experience. The connection should be made in accordance with the previously elaborated, individual electric diagram and according to the motor manual. There is a possibility of individual and group control with one or multi-channel remote control.

Transmitters and receivers should be programmed according to the instructions attached to the engines.

When the awning starts working special attention should be paid to correct rolling up and down of the fabric and proper functioning of limit switches in the motor.



The engine has a thermal switch, which turns off the drive after about 4 minutes of continuous work to protect from overheating. After turning off by the thermal protection appropriate time should pass before turning it on again, depending on the type of engine and atmospheric conditions (several minutes).

List of steps:

- Connection to the electricity supply,
- Connection to the electrical control system.

3.9.1 Connection to electrical installation

After the product is installed one may proceed to connecting the drive and control system to the previously prepared systems: power supply and control systems.

Connection to the power supply system should be made in accordance with the previously elaborated individual electric diagram, including fire protection regulations.

Electrical connection and adjustment of motors should be performed according to the motor manufacturer's manual taking into account the environmental conditions in which the product will be operated.

Regular environmental conditions:

Such conditions are found in e.g. apartments, offices, event and theatre halls, school classrooms (excluding some laboratories) etc.

Environmental conditions of increased threat:

Bathrooms and showers, kitchens, garages, cellars, saunas, rooms for domestic animals, operating theatres in hospitals, pump rooms, heat exchange rooms, spaces limited by conducting areas, campsites, open spaces, etc. are regarded as environments with increased threat conditions.

In rooms and spaces where there are increased threat conditions, automatic devices for switching off power supply to the damaged product should be used, e.g. residual current devices.

Residual current devices:

- Recommended for use in bathrooms, kitchens, garages and cellars,
- They are to be used obligatory at swimming and shower pools, saunas, construction sites, while supplying appliances in open spaces, on agricultural and horticultural farms, on campsites and in camper vans, as well as in rooms where there is fire hazard.

Residual current devices are only supplementary protection from direct contact, they cannot be the only means of protection. The goal of their application is to supplement the protection in case other means of protection from direct fail or in case of user's carelessness.

During installation attention should be paid to usage safety rules, e.g. minimum height electrical appliances can be installed at.

General safe connection guidelines:

- The connection must be performed by electrician possessing appropriate permissions and experience,
- During connection health and safety regulations should be observed,
- Electrical connection and adjustment of motors should be performed according to the motor manufacturer's manual added to the product.





Incorrect connection of the motor can lead to product damage or create a hazardous situation.

3.9.2 Remote operation

Remote operation programming (assigning remote control appliances, weather sensors and other operation elements) should be performed according to the manufacturer's manual added to the product.

3.9.3 Start-up and adjustment

Recommendations and actions:

- extreme position (up and down movement of the fabric) are protected by limit switches that needs to be adjusted during the installation,
- person performing the adjustment of extreme positions should possess adequate electrical permissions, knowledge and experience,
- adjustment of limit switches must be done in accordance with motor's maintenance manual,
- prior to the first start of the product electrical measurements should be performed by person holding adequate permissions,
- do not start the motor without checking the correctness of system installation,
- after the awning is put into motion with a switch do not take off the casings, end covers, lean on the product, leave tools on it,
- after each re-assembly in a new place the product and electrical installation earth circuit should be checked.

When the awning starts working attention should be paid to:

- Correct rolling down and up of the fabric,
- Correct activation of limit switches.



Self-regulation of extreme position by an untrained person may lead to product damage.

3.10 Manual drive

Awning opening is performed by making enough turns with the crank until the arms are opened, keeping the fabric tension.

Awning closure – by turning the crank until gentle resistance is felt.

Gears 11:1 are not equipped with overturn protection (so called mechanical end stop).

During operation of awning with manual drive the force working on the crank is multiplied by gear mechanism and putting too much force can lead to fabric damage, especially when closing the awning.

Do not allow the fabric to be rolled in the opposite direction (from the bottom of roller tube), since it may cause its ripping off the roller tube, fabric damage or incorrect awning functioning.

4 Final remarks

4.1 *Completeness and qualitative state of delivery*

Awning is delivered with installed arms, fabric and wall brackets, with accompanying additional packages.

Selt SP. Z O.O. makes every effort to ensure that the goods are produced in accordance with the order. To check the completeness of the product is purchaser's duty and it should be conducted at the time of delivery. Any discrepancies of the product with the order should be reported immediately to the driver/warehouseman/installers and noted in the proof of delivery at the risk of rejecting claims regarding quantitative discrepancies. Checking the quality of the apparent defects should be done by the purchaser at the time of delivery. As apparent defects are considered mechanical damages, scratches, cracks, etc. Any discrepancies in quantity or possible replacements of parts being the evident result of Selt SP. Z O.O. fault, the company agrees to supplement or replace in the shortest possible time.

4.2 *General conditions for transport and storage of the product*

- The product is factory-packed in a cardboard box to prevent its damage during storage, transport and during its transportation to the place of final assembly,
- For the transport purposes, the products should be set in accordance with the arrows on the packaging,
- Store the product in a way preventing the package from crushing, what in turn may lead to product permanent damage,
- Products placed on the means of transport must be secured against movement and damage during transport (e.g. spacers, safety belts, etc.).
- During transportation the products must be protected from the rain or snow,
- Storage places should be dry, airy and protected from the harmful effects of weather conditions (sun, rain, etc.),
- Where the weight of the product exceeds 25kg and its transportation to the place of final assembly must be carried out by at least two persons.

5. Disassembly/ Utilization/ Disposal



Improper system disassembly can result in severe injuries and system damage. System disassembly should be commissioned to a properly qualified assembly team or to a person suitably trained within industrial safety and with the knowledge concerning recovery.

Disposal of worn electrical and electronic equipment

After the end of product lifetime it must be disassembled and separate material must be segregated according to Regulation of the Minister of Environment of 9 December 2014 on waste catalogue – Dz. U. [Journal of Laws] of 2014 item 1923

Important information concerning utilisation:



Pursuant to the regulations of the Act dated of 11 September 2015 about waste electrical or electronic equipment, it is forbidden to place used appliances marked with a crossed out waste bin symbol jointly with other waste. The User wishing to dispose of electronic or electrical equipment is obliged to take it to the used equipment collection spot.

The above legal obligations were introduced in order to reduce the amount of waste due to used electrical and electronic equipment and to assure a proper level of collection, recovery and recycling. There are dangerous elements in the equipment which are of particularly adverse effect on the environment and human health.

No.	Subject	European legal basis	Polish legal basis
1	Waste electrical and electronic equipment	Directive 2012/19 EU of the European Parliament and of the Council of 4 July 2012 on waste electrical and electronic equipment (WEEE)	Act of 11 September 2015 Dz. U. [Journal of Laws] of 2015, item 1688 on waste electrical and electronic equipment
2	Waste catalogue	Commission Regulation (EC) No. 574/2004 of 23 February 2004 amending Annexes I and III to Regulation (EC) No. 2150/2002 of the European Parliament and of the Council on waste statistics.	Regulation of the Minister of Environment of 9 December 2014 on waste catalogue – Dz. U. [Journal of Laws] of 2014 item 1923.

Disposal of waste batteries

In accordance to the Act of 24 April 2009 on batteries and accumulators final user is obliged to pass waste portable batteries, which are no longer energy source, to a collection spot or to a special collection bin. It is forbidden to put waste batteries in the same container as other waste.

In order to prevent environment pollution and posing possible threat to human and animal health, dispose of the used battery to a proper collection bin in the assigned collection spots.

No.	Subject	European Legal Basis	Polish Legal Basis
1	Waste batteries and accumulators	Directive 2006/66/EU of the European Parliament and of the Council of 6 September 2006 on waste batteries and accumulators and repealing directive 91/157/EEC	Act of 24 April 2009 on batteries and accumulators Dz. U. [Journal of Laws] of 2009 no. 79, item 666

6. Marking and labelling the product with CE mark



6.1 Product compliance with the CE standard

Products manufactured by SELT company meet the essential requirements of the standard introduced by the Polish Committee for Standardization as PN-EN 13561, which is confirmed by the manufacturer's declaration of performance and marking the product with the CE mark.

In order to maintain this condition and assure safe use and maintenance of the system, the installation and operating manual and instructions for safe use must be observed.

6.2 Information accompanying the CE mark

a) Marking on the product:

	
SELT Sp. z o.o. OPOLE, ul. Wschodnia 23a	SELT Sp. z o. o. Opole, ul. Wschodnia 23A
EN 13561	2006/42/EC

b) Marking on the accompanying documents:

<p>SELT Sp. z o.o. OPOLE, ul. Wschodnia 23a POLAND 07</p>
<p>EN 13561</p> <p>Awning JAMAICA 410x310 for external use. Wind load resistance: 2 class DWU 10 / M / 2017</p> <p>Awning JAMAICA 700x360 for external use. Wind load resistance: 1 class Total solar energy transmittance g tot: 0,01-0,90*</p> <p>DWU 25 / M / 2017</p>

<p>SELT Sp. z o.o. OPOLE, ul. Wschodnia 23a POLAND 07</p>
<p>Awning with folding arms JAMAICA JAMAICA with Volant 230V/ 50 Hz Power 198 to 275 W 01 / DZ/2017</p>

*- external sun protection screen with glazing type C according to EN 14501:2005; detailed data depending on the fabric type are given in a table on manufacturer's website